

Brabant Energy Leaders

December 2023

- Introductie Ennatuurlijk
- Hoe werkt aardwarmte
- Ennatuurlijk in Brabant
- Aardwarmte voor industrie



ennatuurlijk aardwarmte

By 2026 we are the recognised leading brand for **zero impact geothermal energy production in The Netherlands.**



Setting the standards for the industry with **impeccable safety record**



Owning and operating **a major part of the geothermal energy production in The Netherlands**



The place **talent wants to work**

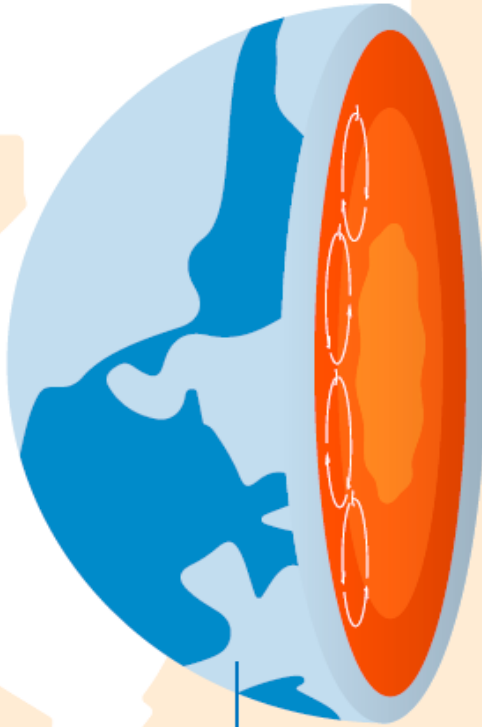

**Zero impact
100% sustainable
heat for all**

Inner core
= 5.700 to
6.378 km

Outer core
= 2.900 to
5.100 km

Mantle
= magma
= to 2.900 km

Crust
= 8-40 km

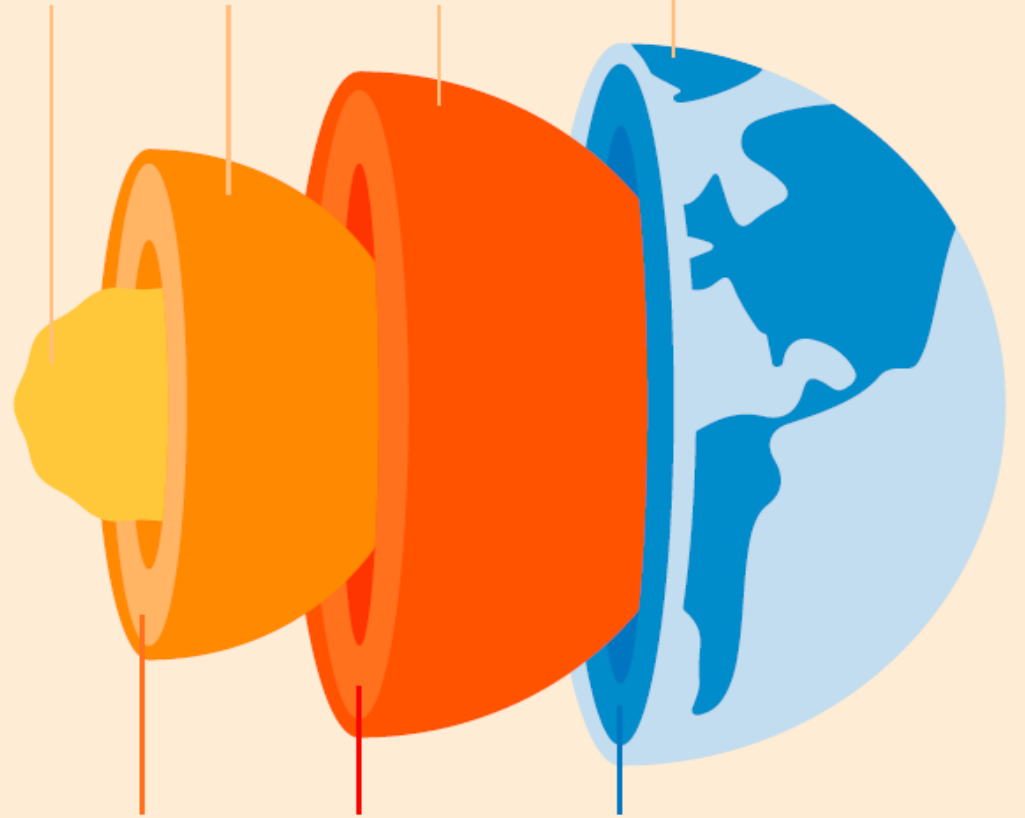

Why

Release the unlimited energy of the earth with zero impact!

How

Accelerate the market by scaling geothermal energy

What

Produce reliable, affordable, safe & sustainable heat

Introductie Ennatuurlijk

- Aardwarmte is voor Ennatuurlijk de bron om te verduurzamen en te groeien
- Geïntegreerde keten voor optimale ontwikkeling
- Lange termijn perspectief vanuit aandeelhouder

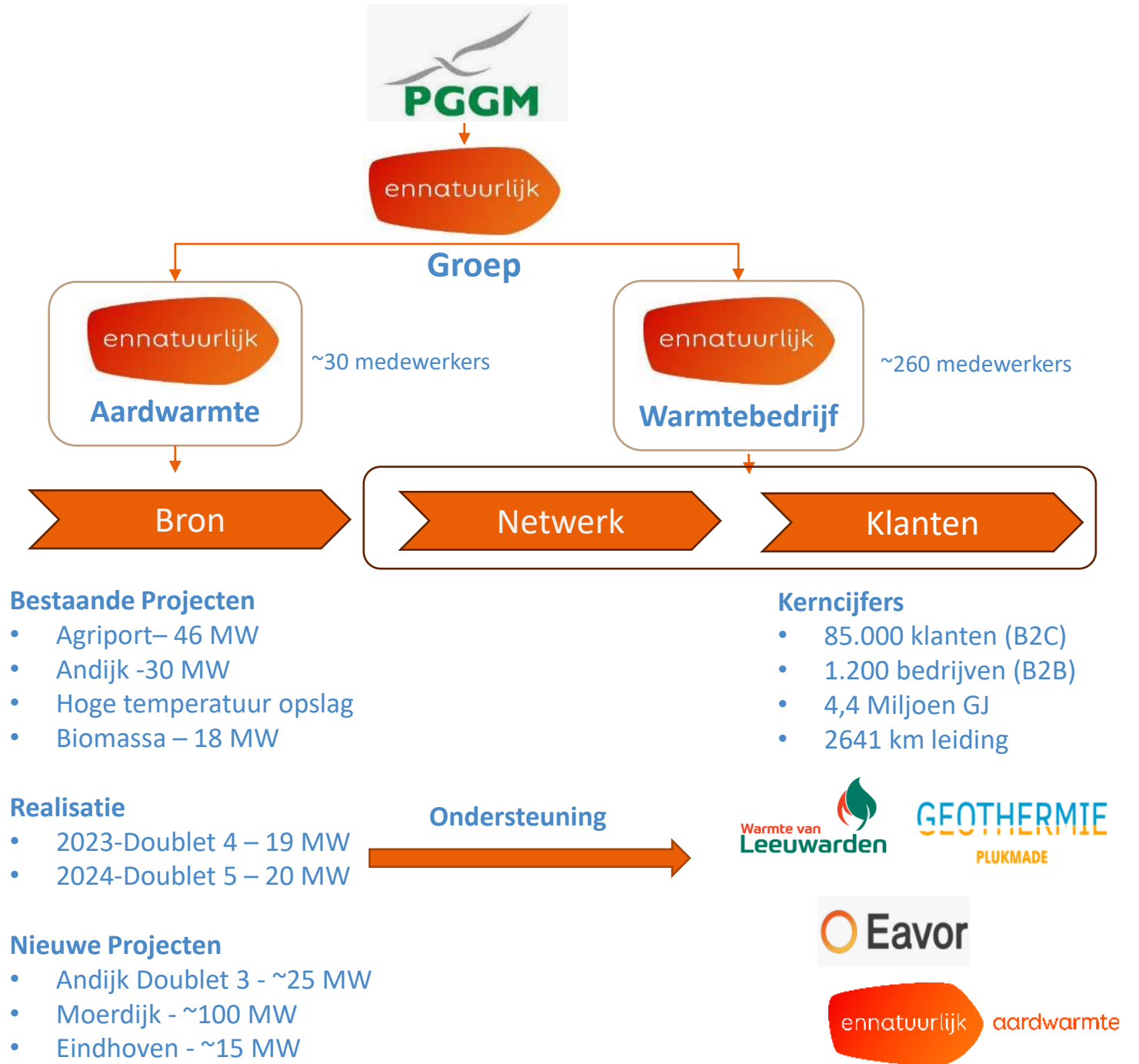

Aardwarmte

- Ca. 30 graden per km in NL
- Ontwerp systeem ca 30 jaar, daarna (beperkte) temperatuur daling
- In NL vooral van belang om doorlaatbare aardlagen te vinden

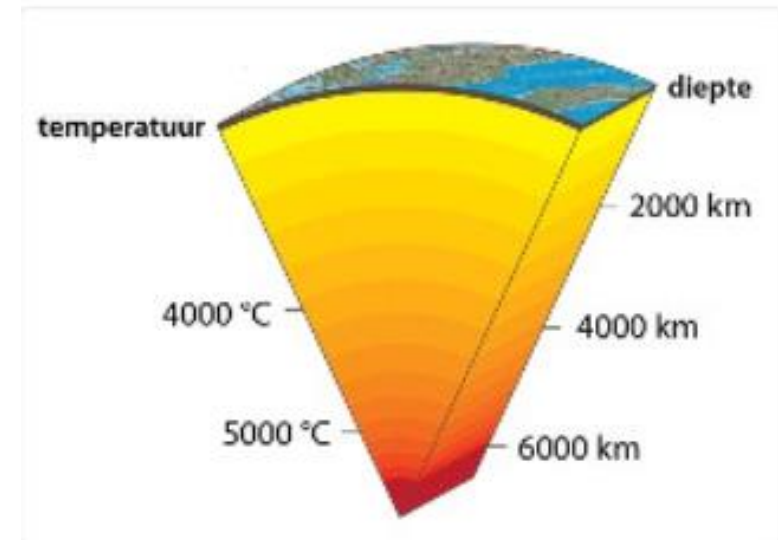
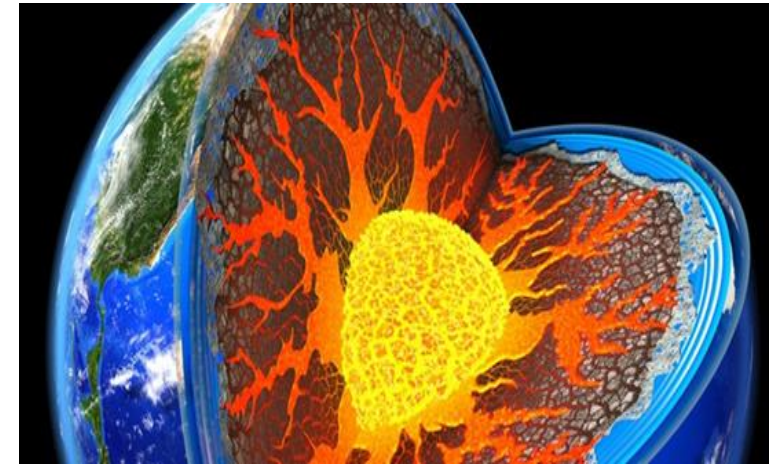
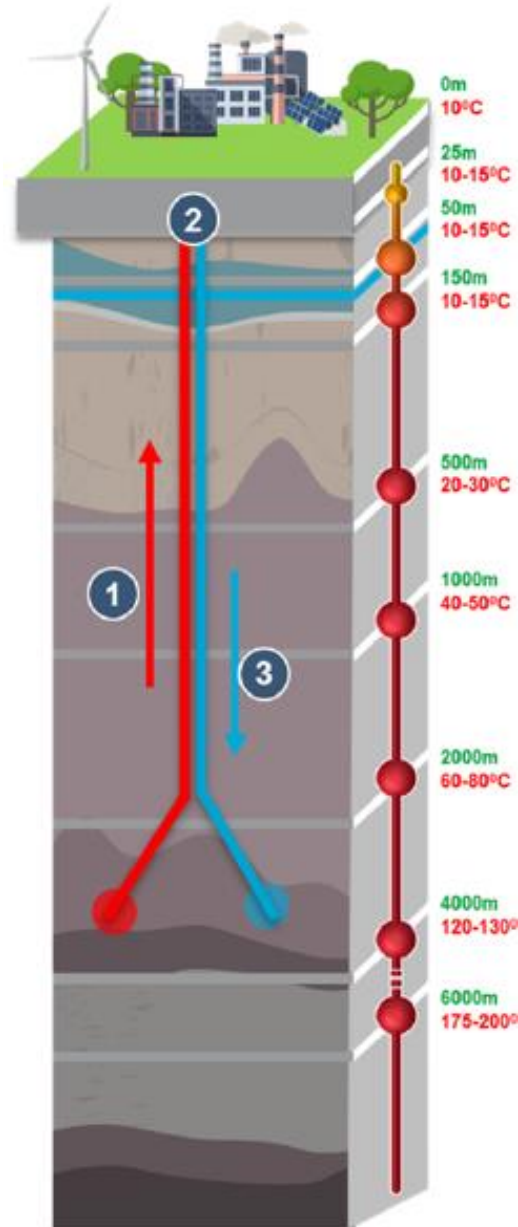

Ennatuurlijk In Brabant

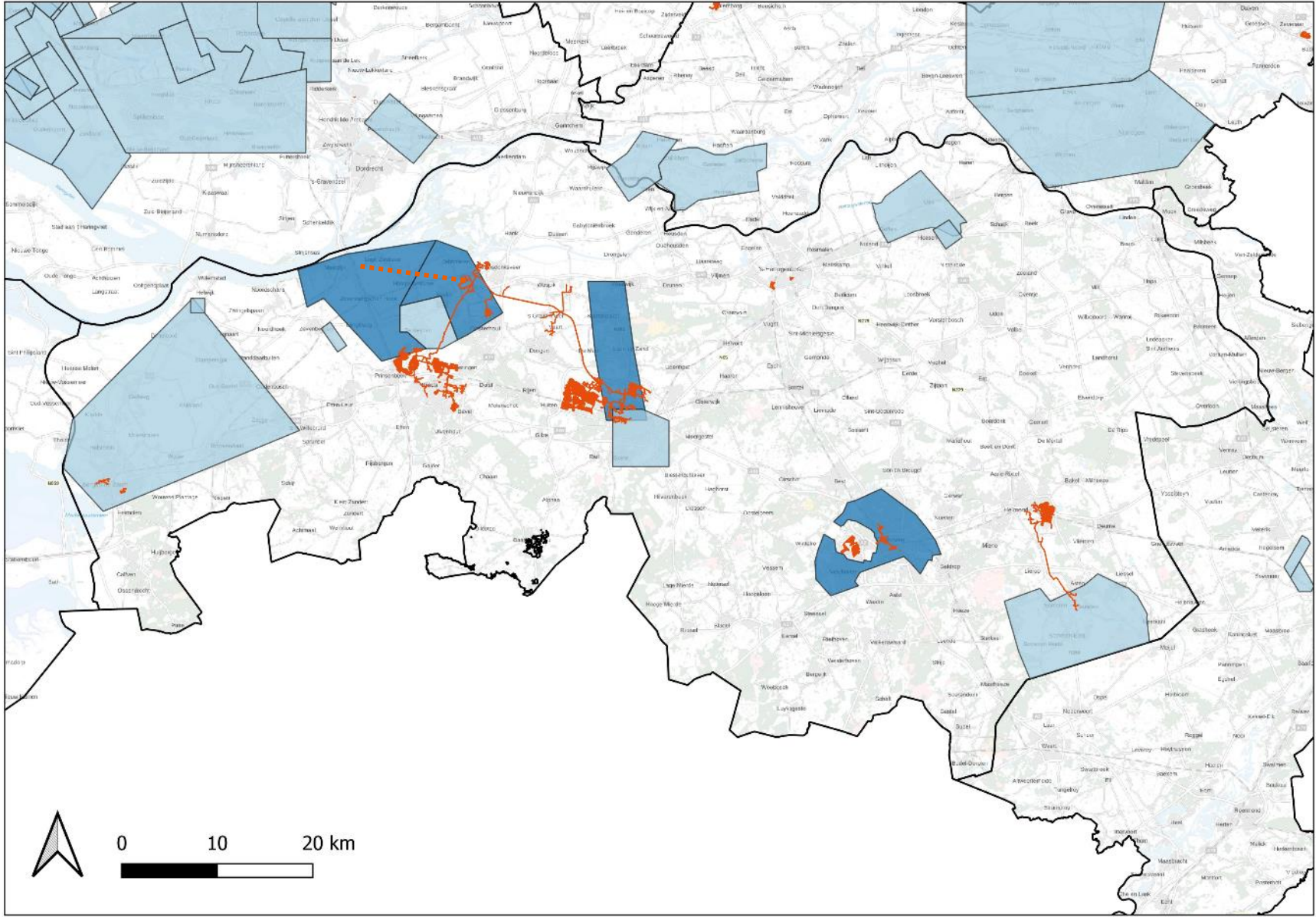

Match Aardwarmte & industrie

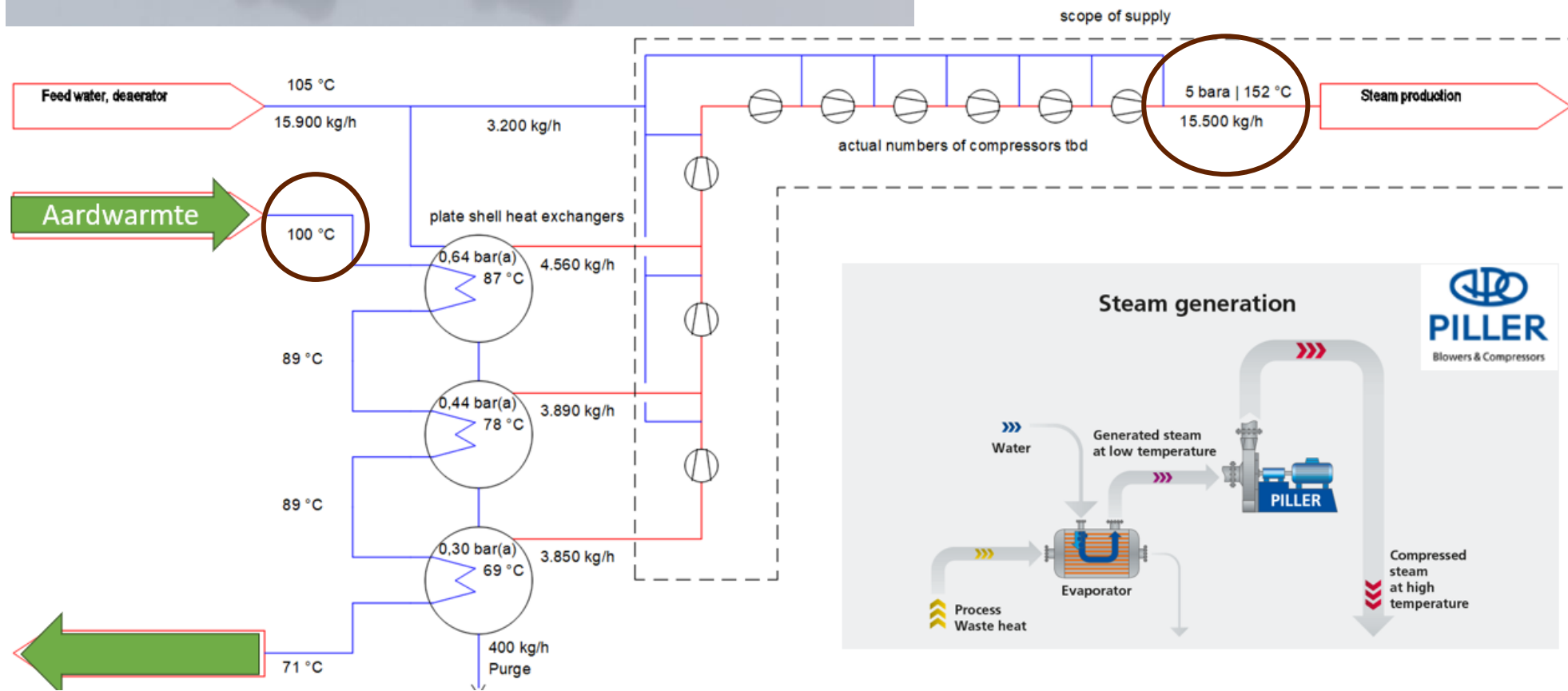
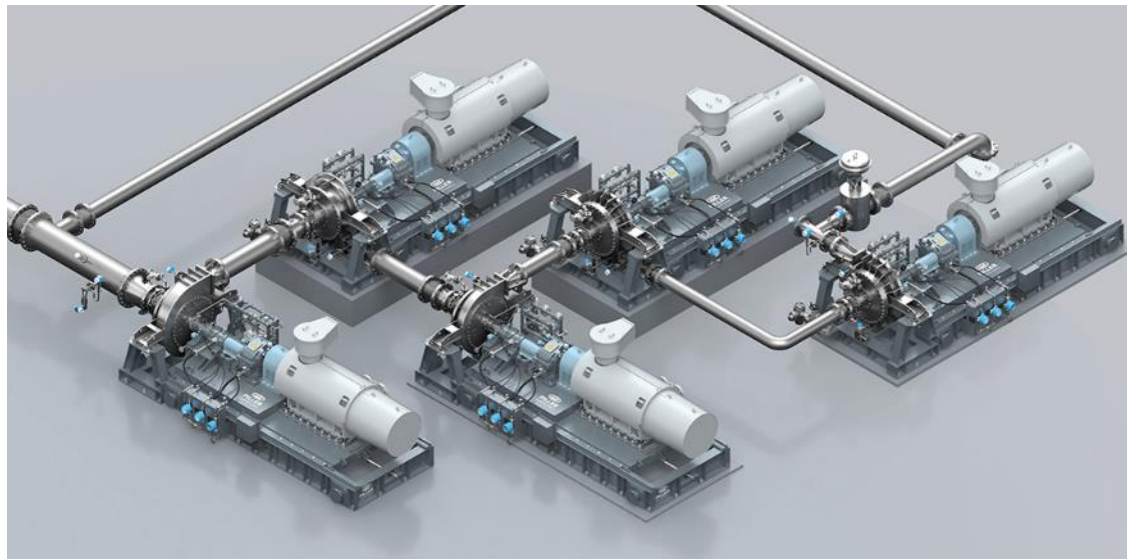

Dank voor uw aandacht en interesse !

ennatuurlijk aardwarmte

Nieuwe Aardwarmte- Centrale



ressie
lijk

